

KS-16S

User

Manual

CAUTIONS

Electric unicycle is designed for the outdoors and short distance personal transport.

SAFETY IS THE NUMBER ONE PRIORITY!
PLEASE RIDE UNDER LOCAL LAW!

The user manual below is a quick and convenient guide of safety & item functions/features to end user. We can't ensure all types of situation emergency are covered. Therefore, we **STRONGLY** remind you to read this guide very carefully, and ride with attention to ensure your safety.

Riding like all outdoor activities comes with it's risks. You risk serious danger and injury if you fall, collide or lose of control when riding, please ride with caution and at your own risk.

Thanks you for purchasing King Song smart electric unicycle!

Contents

1. Product Details-----	01
2. Safety Instructions-----	07
3. APP-----	11
4. Learn to Ride-----	12
5. Warning-----	15
6. Maintenance-----	19
7. Warranty-----	21

1. Product Details

1.1 Diagram: KS-16S

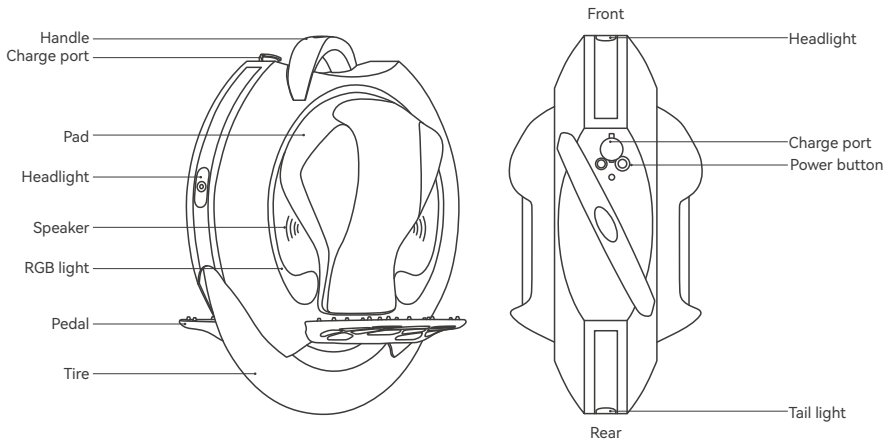

Accessories



Charging Adapter



User Manual

1.2 Specifications

Model No.	KS-16S	
Rated power	1200W	
Peak power	3000W	
Max speed	Full speed unlocked after 5km. Max speed of 35km/h (Factory alarm settings: 18km/h first level alarm, 19km/h second level alarm, 20km/h third level alarm and warp plate).	
Grade-ability	Around 30°	
Battery	Rated Power: DC 60V Top Charging Voltage: DC 67.2V Rated Capacity: 840Wh / 420Wh Battery pack with equalization, overcharge and short circuit protection.	
Mileage	Around 70-80kms	Around 30-40kms
Max load	120kg	
Adapter specs	Input AC 80~240V / Output DC 67.2V 2A	
Charging time	Around 7hrs	Around 3.5hrs

Working temperature	-10°C / +60°C	
Color	White, Rubber black	
Appearance & weight		
Product size	463(L)*236(W)*506(H)mm	
Package size	540(L)*270(W)*585(H)mm	
Pedal distance from the ground	120mm	
Tire size	16*2.125inch	
Weight	Around 17.4kg	Around 15.8kg
Port	Charge port, Power button, Light sensor, USB port, Fuse port.	
Battery indicate	Led shows battery level when EUC on at rest.	
Protective Measures		
Lift sensor	Lift sensor accurately senses and determines when wheel is lifted off the ground to stop tire rotation.	
Roll protection	45° left and right side. (Motor stalls when over 45°)	

	Place the machine vertically on the ground will restart automatically, no need to restart manually.
Speed limit protection	Beep alarm or voice alarm when exceed limit speed.
Low battery protection	Low battery protection activated on 30% battery, speed will decreases linearly; when the battery is lower than 5%, voice alarm for charge, when battery at 0%, the front part of the pedal will rise to decelerate until full stop.
Higher temperature protection	When the motherboard reaches 80°C it will result tilt-back. When the motor reaches 120°C it will result in tilt-back.
Motherboard Waterproof Protection	The motherboard is treated with sealant, greatly enhancing the waterproof performance.
Pedals anti-slip protection	Uniform force on the pedals with raised small columns which is more effective than traditional sand sticking to protect anti-skid, greatly improving safety performance and riding experience.
Power pad	The protection pad are ergonomically designed to use the safe foams, which is moderate, easy to accelerate and decelerate and also better to protect the body.

Alarm & Features	
Switch On/Off	Short press power key: turn on Long press: hear a click then turn off
Battery indicate	Led shows battery level when EUC power on at rest.
Voice remind	The EUC down buzzer beeps alarm 5s Voice prompt function: “Your device is in low battery, please charge it” “Please decelerate” “Bluetooth is connected” “Bluetooth is disconnected” “Be caution, over voltage” “Be caution, over power”.
Hardware Features	
Motherboard	The motherboard is attached to the magnesium alloy base for better heat dissipation, which provides a strong guarantee for fast and stable operation. The turbine inverter fan automatically adjusts the air volume according to the temperature of the main board.
Bluetooth	Bluetooth 4.0. stronger compatibility and allowing strong stable data transmission.
Headlight & tail light	Front and rear light sensing system to ensure your safety at night.

Temperature system	Temperature of the motherboard and motor is continually monitored to ensure rider safety.
Handle	Aluminum constructed handle designed for ergonomic pushing of the wheel or lifting of the wheel.
Motor	Higher power 1200w motor that provides a maximum torque of 80N.m providing fast acceleration.
Battery	Using 18650 batteries, the 16S is designed with two independent batteries, the battery protection board adopts a new battery management system, real-time monitoring of battery cell safety.
Protection pad	With the dual functions of acceleration pad and protection pad, the acceleration and deceleration during riding are more stable and safer.
Bluetooth speaker	Equipped with surround sound Bluetooth audio, better sound quality.
Package	
Standard accessories	1*Charger, 1*User manual, 1*QC certificate

2. Safety Instructions

● 16S is an entertainment product, Which is different from motor vehicles driving on the road. Before mastering riding skills, you need to practice. Kingsong is not responsible for any injuries or damage caused by a rider's inexperience or failure to follow the instructions in this document.

● Please understand that you can reduce the risk by following all the instructions and warnings in this manual, but you cannot eliminate all the risks. Remember that whenever you ride the 16S you risk injury or death from loss of control, collisions, and falls. When entering into public spaces always comply with the local laws and regulations. As with other vehicles, faster speeds require longer braking distance. Sudden braking on smooth surfaces could lead to wheel slip, loss of balance, or falls. Be cautious and always keep a safe distance between you and other people or vehicles when riding. Be alert and slow down when entering unfamiliar areas.

● Respect pedestrians by always yielding the right of way. Pass on the left whenever possible. Avoid startling pedestrians. When approaching from behind, announce yourself and slow

down to walking speed when passing.

- In places without laws and regulations governing selfbalancing electric vehicles, comply with the safety guidelines outlined in this manual. Kingsong is not responsible for any property damage, personal injury/death, accidents, or legal disputes caused by violations of the safety instructions.

- Make sure each new rider wears a helmet and other protective gear.

- Before each ride check for loose fasteners, damaged components, and low tire pressure. If the 16S makes abnormal sounds or signals an alarm, immediately stop riding. Contact your dealer/distributor for service.

- Always wear a helmet when riding. Use an approved bicycle or skateboard helmet that fits properly with the chin strap in place, and provides protection for the back of your head.

- Do not attempt your first ride in any area where you might encounter children, pedestrians, pets, vehicles, bicycles, or other obstacles and potential hazards.

- Use caution when riding in new environments.

- To reduce risk of injury, you must read and follow all “WARNING” notices in this document. Do not ride at an unsafe speed. Under no circumstance should you ride on roads with motor vehicles. Always follow these safety instructions:
 - A) The following people should not ride 16S:
 - i. Anyone under 18 years old or above 50 years old.
 - ii. Anyone under the influence of alcohol or drugs.
 - iii. Anyone who suffers from disease that puts them at risk if they engage in strenuous physical activity.
 - iv. Anyone who has problems with balance or with motor skills that would interfere with their ability to maintain balance.

 - B) Comply with local laws and regulations when riding this product. Do not ride where prohibited by local laws.

 - C) To ride safely, you must be able to clearly see what is in front of you and you must be clearly visible to others.

- D) Do not ride in the snow, in the rain, or on roads which are wet, muddy, icy, or that are slippery for any reason. Do not ride over obstacles (sand, loose gravel, or sticks). Doing so could result in a loss of balance or traction and could cause a fall.
- E) Do not accelerate or decelerate suddenly. Do not accelerate when the 16S tilts back or sounds an alarm. Do not attempt to override the speed limiter.
- F) While the Kingsong App is useful, do not allow the App to distract you while you are riding. Always pay attention to your surroundings.
- Never restart and ride your 16S after it has indicated an empty battery condition or powered off due to low battery. Your 16S may not have enough power to keep you balanced, especially if you demand a lot of power at once. If you restart and continue riding, you risk falling. Also, you risk damaging your batteries, resulting in reduced battery life and capacity.
 - Do not insert the power cord if the charge port is wet.

- Use a surge protector when charging to help protect your 16S from damage due to power surges and voltage spikes. Do not use a charger from any other product.
- Always shut down your 16S and unplug the AC Power Cord before performing any maintenance.
- Do not modify your 16S. Modifications to your 16S could interfere with the operation of the 16S, could result in serious injury or damage, and could void the Limited Warranty.

3. APP

- For Android apk: Please download from Google play, 'kingsong' is the exact one.
- For IOS app: Please download from apple store, 'kingsong' is the exact one.



KingSong APP(Android)



KingSong APP(IOS)

4. Learn to Ride

4.1 Precautions

- Please find a surface to practice on.
- Warm up your body and ensure you're wearing safety gear such as helmets, knee pads, elbow pads and wrist guards.
- Ensure the wheel's battery level.
- Check the unicycle for imperfections such as any looseness, abnormal sound. We also highly suggest pushing the unicycle by ahnd to see if there's any friction between tire and the case of the wheel.
- Please do not accelerate or decelerate rapidly, please also try to avoid over leaning or leaning too fast to prevent rider injury.

4.2 Start Learning to Ride

- Like riding a bicycle or unicycle, it takes a certain skill level to ride Kingsong 16S. For different customers, it may take 2-20 hours to ride well.

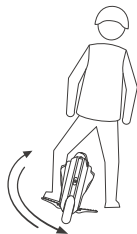

01. Get used to the way Kingsong 16S: step on one pedal, then swing your leg back and forth to feel the controls.

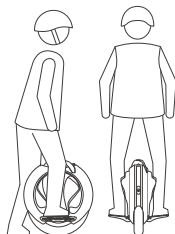

02. Using a friend, wall, or handrail: put both feet on Kingsong 16S and practice riding slowly forward and backward.



03. With one foot on a pedal, slowly lean forward. Push off with your other foot and glide for 1-2 seconds.

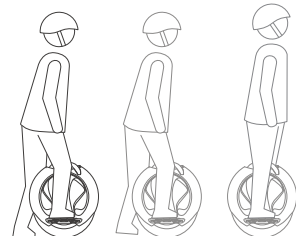

04. After you are able to comfortably glide for a few seconds, try gliding for 10-20 ft (3-5 m) with both feet on the pedals.

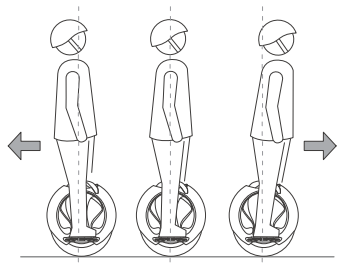

05. Practice travelling forward and backward by controlling your body's center of gravity. The further you lean, the faster you go.

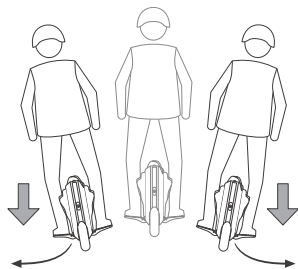

06. Turn by pressing harder on one pedal than the other, and by shifting your weight slightly.

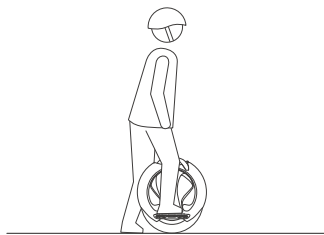

07. To get off: come to a stop by centering your weight, then step off Kingsong 16S with one foot.

5. Warning

- You must read and understand the Warning Instructions section of this manual before attempting to ride the 16S.

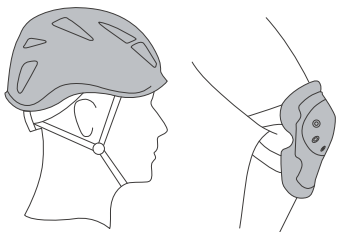

- Always wear a helmet and protective clothing when riding.

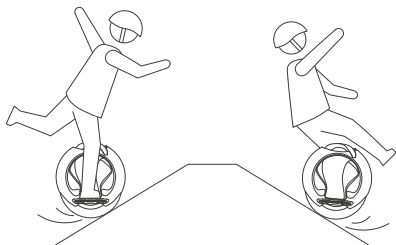

- Use caution when riding on slopes. Avoid riding on steep slopes.

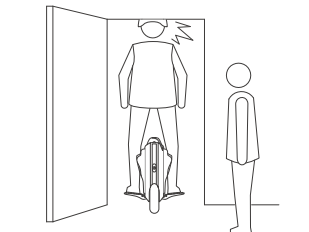

- Watch your head when passing through doorways.



- Use caution when riding over any changes in terrain.



- Do not ride on limited traction surfaces.

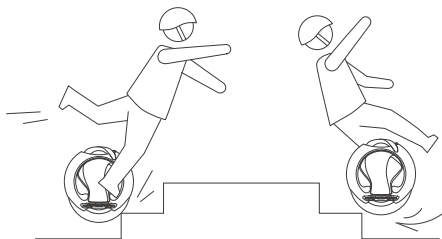

- Do not ride over holes, curbs, steps, or other obstacles.



- Do not rock back and forth or shift your weight abruptly.

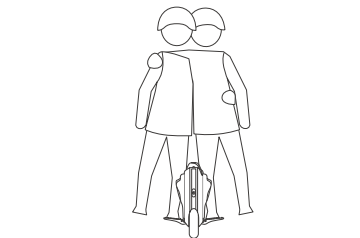

- Do not ride double or carry any passengers.

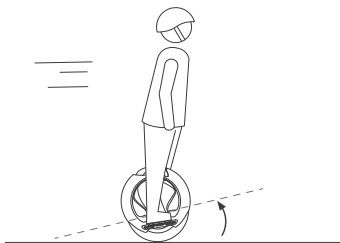

- Do not accelerate when the Kingsong 16S tilts back or sounds an alarm.

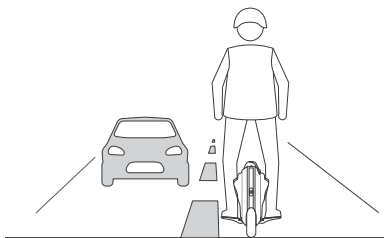

- Do not ride on public roads, motorways, or highways.

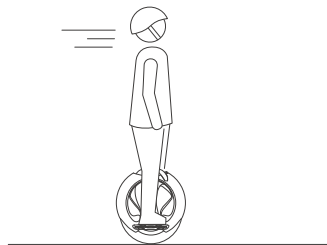

- Do not exceed the speed limit of 35km/h.

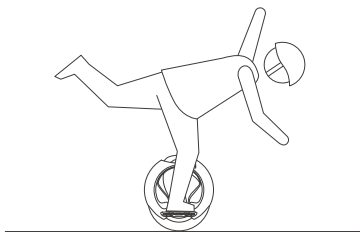

- Do not ride with single leg on the pedal

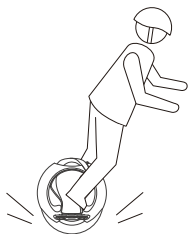

- Maintain contact with the ground at all times. Do not jump or attempt stunts.

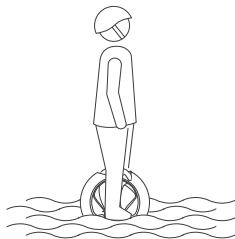

- Do not get wet. Do not ride through puddles or other bodies of water.

6. Maintenance

6.1 Cleaning

WARNING

- Make sure the 16S is powered OFF, the charge cable is unplugged, and the silicone cap on the charge port is tightly sealed before cleaning; otherwise you may expose yourself to electric shock or damage the electronic components. Do not wash your 16S with a power washer or high pressure hose.
- Wipe your 16S clean with a soft, wet cloth. For stubborn stains, use a toothbrush and toothpaste.

NOTE

- Do not wash your 16S with alcohol, gasoline, acetone, or other corrosive/volatile solvents. These substances may damage the appearance and internal structure of your 16S.

Storing

- Store the vehicle in a cool, dry place. Do not store it outdoors for extended periods of time. exposure to excessive sunlight or temperature extremes (both hot and cold) may affect the vehicle's appearance, battery life, and tires.

6.2 Battery Maintenance

WARNING

- Do not attempt to disassemble the battery.
- Do not allow the battery to get colder than -20°C or hotter than 50°C , e.g. in a car. Do not expose the battery to fire. Do not discard or destroy the battery. Refer to your local laws and regulations regarding battery recycling and/or disposal.
- To extend the battery's life, charge it frequently and avoid draining the battery completely. At 30°C the battery range and performance is at its best; whereas at temperatures below 0°C range and performance are decreased. Typically, at -20°C range can be half that of the same battery at room temperature. Battery range will recover when temperature rises.

Temperature($^{\circ}\text{C}$)	-20	-10	0	10	20	30	40	50
Range	40%	60%	80%	90%	95%	100%	105%	110%

NOTE

A fully-charged 16S can be stored for about 120 to 180 days before requiring charging. Completely draining the battery may cause permanent damage to the battery. Electronics

inside the battery record the charge-discharge condition of the battery; damage caused by over-discharge or under-discharge will not be covered by the Limited Warranty.

7. Warranty

For warranty policy, please consult with the point of purchase or email to the manufacturer's service team:

support@szkingsong.com

Again, we appreciate your purchasing of Kingsong products.



Kingsong Intell Co.,LTD

Address : BLDG 7, NO 71 XINGHU RD, 8TH INDUSTRY PARK,
HONGXING, YUTANG,GUANGMING,SHENZHEN

Tel : +86-755-23193476

E-mail : info@szkingsong.com

